



DOREL MAXI-COSI **PRIA 85 MAX**

Type: Convertible
Last date made: 2021
First made: 2017

Weight limits: 5 to 40 lbs. rear-facing, 22 to 85 lbs. forward-facing; forward facing not recommended for children under two.
Harness: 5-point harness

Harness: Shoulder straps are attached to a splitter plate behind seat. Pull strap end in front of seat to tighten harness. Push lever at lower front of seat and pull on shoulder straps to loosen. Set of harness pads for larger children is located in pocket on upper side of restraint (diagram 1). **Only use these harness covers if child weighs more than 65 lbs. and restraint can not be tethered.** Chest clip contains a magnet—do not use on child who has an implanted electronic medical device. Caregiver should contact Dorel for a non-magnetic replacement chest clip at no charge.

Harness Slots: There is one set of slots which may be raised or lowered by squeezing lever at top of headrest and moving up or down (diagram 2). Be sure headrest is locked into position after adjusting.

Crotch Strap: Crotch strap is sewn to a metal anchor which must lie flat against bottom of restraint. There are three slots. To change position, fully recline restraint and reach under seat between base and shell. Twist metal anchor sideways, thread through slot in restraint, and insert into desired slot. Inner or middle slot must be used for rear-facing. Any slot is acceptable for forward-facing use; buckle should be close to, but not underneath, child.

Angle Adjustment: There are three positions. Use position 2 or 3 (diagram 3) for rear-facing. Level line on side of restraint (diagram 4) must be level with ground. If restraint is used forward-facing, position 2 **must** be used if child is 22-40 lbs.; position 1 (diagram 5) **must** be used if child is 40-85 lbs. To adjust angle, pull out on handle on back of restraint (diagram 6).

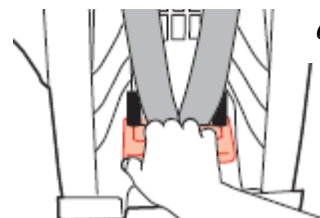
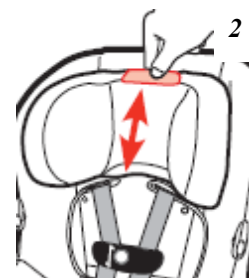

SEE PAGE 2

Belt Path: If LATCH is not in use, secure connectors based on orientation of restraint, to locations provided on sides of shell as shown in diagram 7. **Do not install restraint using inflatable safety belt.**

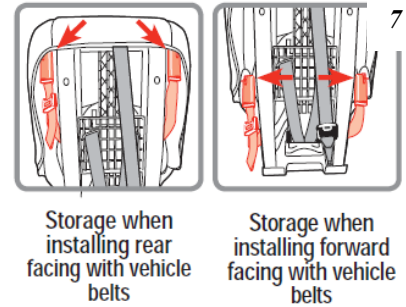

Rear-facing: Vehicle belt is routed under child's legs through slots on each side of shell. Route lap-only belt through belt positioning guides at belt path on both sides of shell. If installing with lap-shoulder belt, route only the lap portions through belt guides (diagram 8).

Forward-facing: Vehicle belt is routed through slots behind child.

LATCH: There is a single attached strap. Thread strap through appropriate set of slots for either rear facing or forward-facing use. When rear facing, route LATCH strap through belt positioning guides at belt path on both sides of shell (diagram 9). Arrows on connectors must face up. Discontinue use of lower anchors when child is 40 lbs. Lower LATCH bars may be used in center seating position when position is designated as a LATCH location in vehicle owner's manual and space between bars is at least 11 inches (refer to Safe Ride News LATCH manual).

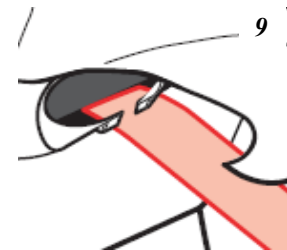
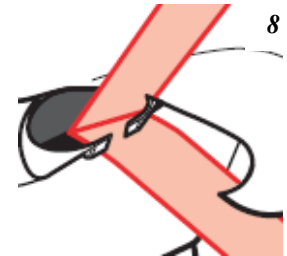

Tether: Yes, for forward-facing use only. If tether is not in use, secure hook behind restraint (diagram 10).

Other: Infant positioning wedge (diagram 11) must be used for child 5-11 lbs. and must be removed when child exceeds 14 lbs.

Body pillow (diagram 12) may only be used in rear-facing mode.

Restraint expires ten years from date of manufacture.

DOREL brands include: COSCO, EDDIE BAUER, SAFETY 1st, MAXI-COSI, ALPHA ELITE and ALPHA SPORT. Model names may apply to any one or more of these brands. Some model names may be discontinued.

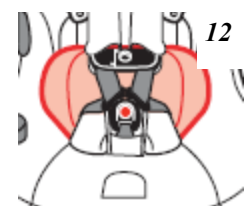
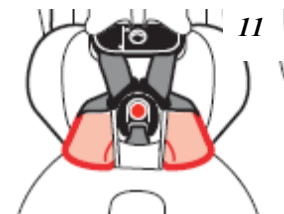
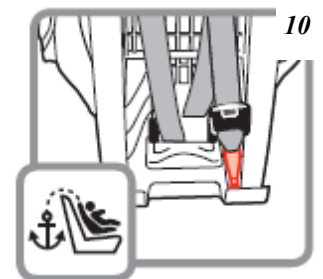



© 2016 Dorel Juvenile. All Rights Reserved.

4358-7153
1.20.17



Pria 85 Max

Convertible Car Seat

Rear Facing

5-40 lb (2.3-18 kg) and **40 in.** (101.6 cm) or less

Forward Facing

22-85 lb (10.1-38 kg) and **29-52 in.** (73.6-132.1 cm)

At least 1 year old

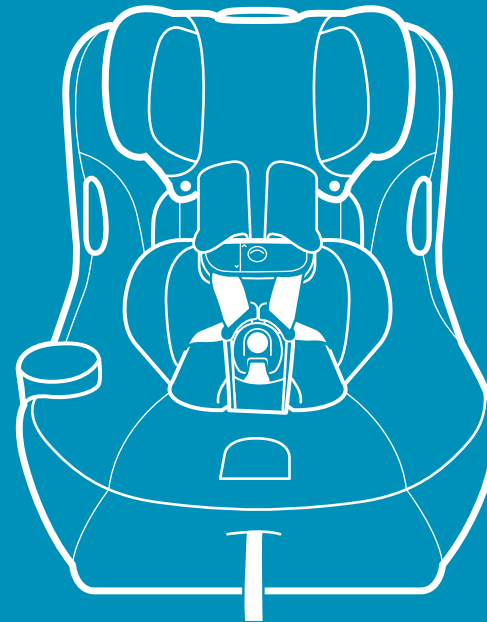

KEEP INSTRUCTIONS FOR FUTURE USE.
Read all instructions before using this child restraint.

⚠ WARNING:

Failure to follow the warnings on the labels and in the instruction manual can result in serious injury or death to your child.

Choosing Rear or Forward Facing

Your child's height, weight, and age determine how your child restraint should be placed in the vehicle.

Please talk to your doctor about the best option for your child.

⚠ WARNING: Verify your child's weight and height (do not guess) before choosing the child restraint's placement.

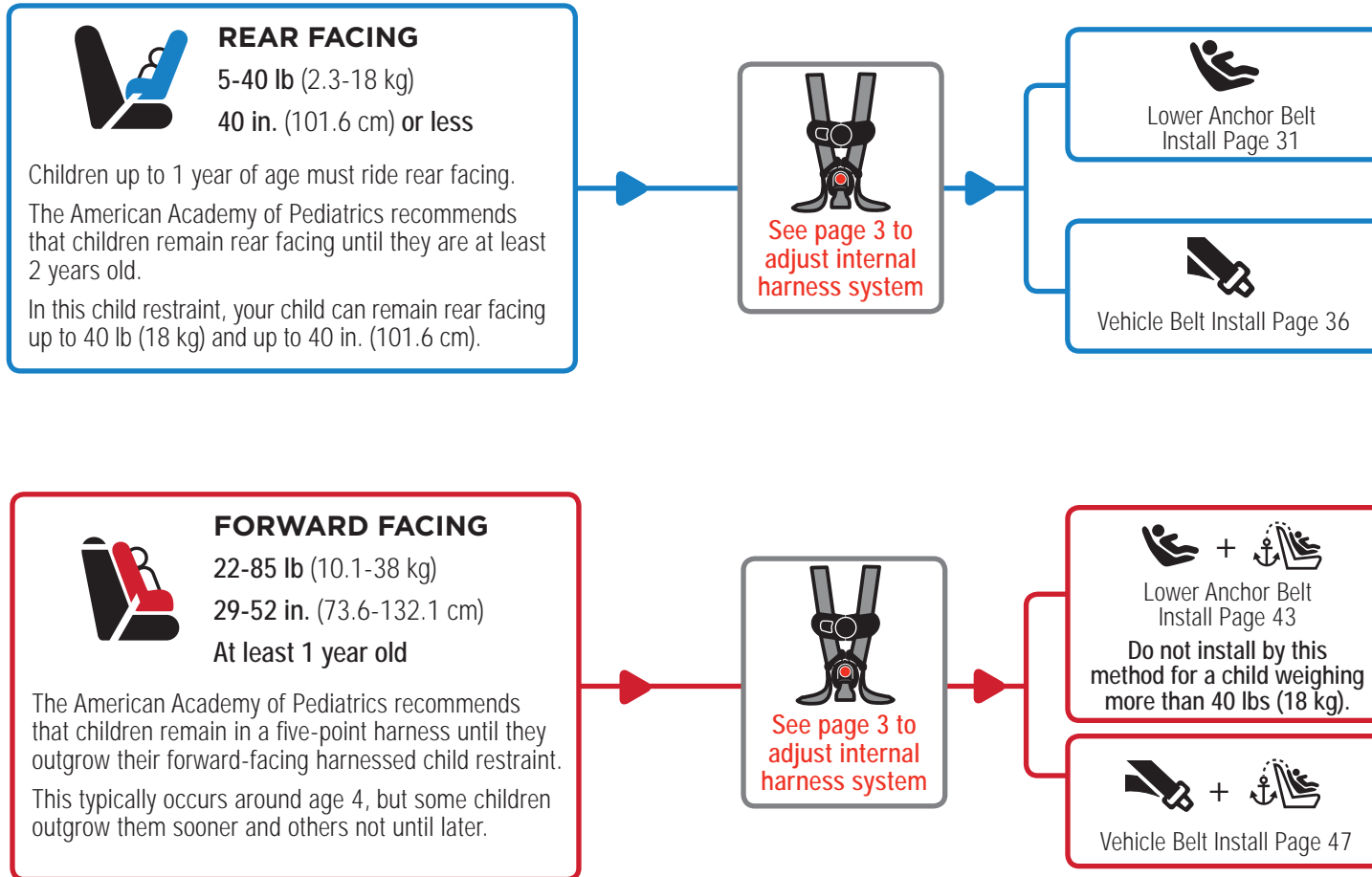

Table of Contents

Getting Started 1

Parts of the Child Restraint.....	1
Prepare Child Restraint to Fit Your Child	3
How Does Your Child Fit?	5
Changing Position of Buckle	7
Adjusting Headrest/Harness Height	9
Securing Child in Child Restraint.....	10

General Use..... 13

Reclining Child Restraint	13
Removing Seat Pad for Cleaning.....	14
Installing Seat Pad.....	16
Accessories on Select Models	19

Safety Information 21

Child Restraint Use	21
Installation in Vehicle	21
Vehicle Seating Position.....	22

Vehicle Information..... 23

Choosing Lower Anchor Belt or Vehicle Belts	23
Knowing Your Vehicle Belts.....	26
Aircraft Information	29

Rear Facing..... 30

 Lower Anchor Belt Installation	31
 Vehicle Belt Installation	36

Forward Facing 40

 Tether Use.....	42
 Lower Anchor Belt Installation	43
 Vehicle Belt Installation	47

Important Information 50

Using a Locking Clip	50
Registration and Safety Notices	53
Warranty.....	54
Replacement Parts Order Form.....	56
Troubleshooting.....	58
Dorel Juvenile Group Information.....	58

Parts of Your Child Restraint

Front View

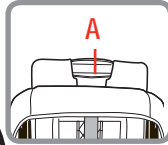
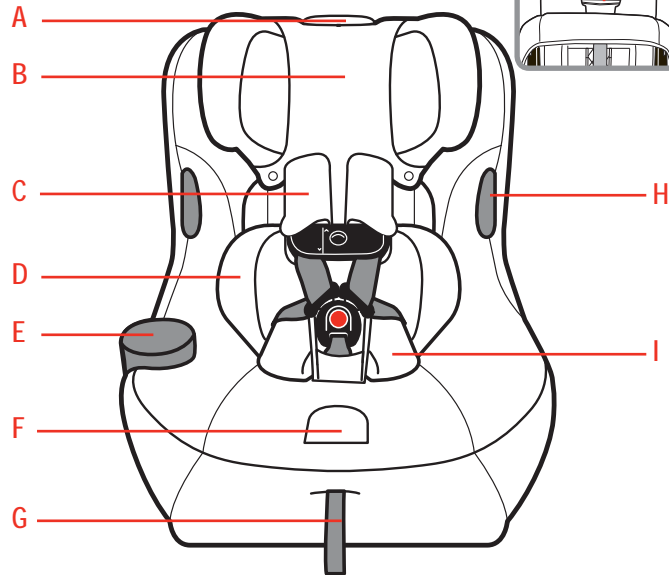

- A.** Headrest/Harness Adjustment Handle (on back of headrest)
- B.** Adjustable Headrest
- C.** Harness Covers (see page 19)
- D.** Body Pillow
- E.** Cup Holder
- F.** Harness Release Lever (under flap)
- G.** Harness Adjustment Strap
- H.** Harness Holders
- I.** Soft Infant-Positioning Wedge (see page 20)
- J.** Shoulder Harness Slots

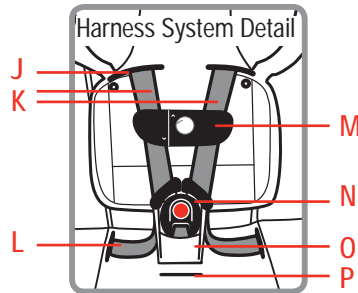

- K.** Harness Straps
- L.** Hip Harness Slots
- M.** ClipQuik™ Chest Clip
- N.** Buckle
- O.** Easy Out Buckle Cover (see page 19)
- P.** Buckle Slots

Side View

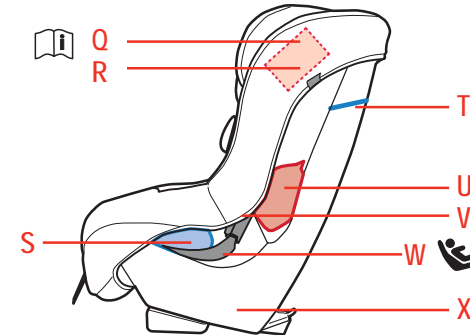

Back View

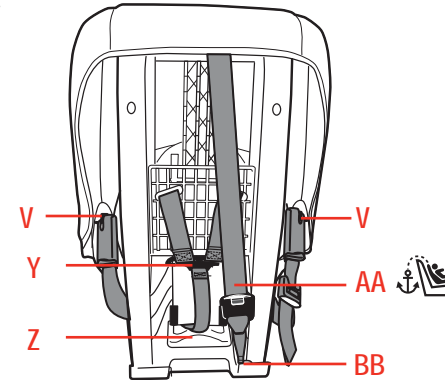

- Q.** Instruction Manual Storage (in pocket on side of pad)
- R.** Harness Covers for Larger Children (in pocket on side of pad)
- S.** Rear-Facing Belt Path
- T.** Rear-Facing Level Line
- U.** Forward-Facing Belt Path
- V.** Lower Anchor Belt Attachment for Storage
- W.** Lower Anchor Belt (see page 24)
- X.** Shell (child restraint)
- Y.** Splitter Plate
- Z.** Recline Handle
- AA.** Tether (see page 42)
- BB.** Tether Attachment for Storage

Prepare Child Restraint to Fit Your Child

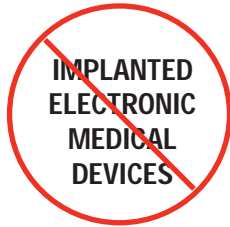

⚠ WARNING: Do not use this chest clip with children who have an implanted electronic medical device.

A magnet is used to help secure the chest clip locking mechanism together which may interfere with the proper function of an implanted electronic medical device.

Parents or caregivers who have an implanted electronic device should keep their device away from the chest clip and consult their doctor and medical device manufacturer for specific information before using this chest clip.

If a parent/caregiver or child has an implanted electronic medical device, please contact Dorel (see page 58) for a replacement (non-magnetic) chest clip free of charge.

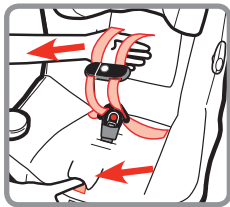

1. Fully Loosen Harness Straps

Push down on harness release lever (through opening in pad) while pulling out on harness straps as shown.



2. Unbuckle Harness

Press in towards the top of the red button.

Pull buckle tongues out.

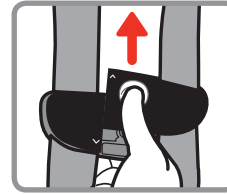

3. Release Chest Clip

Hold the chest clip with one hand and press in on the button with your thumb as shown.

While holding the button in, slide the chest clip up to release the magnet and separate the chest clip.

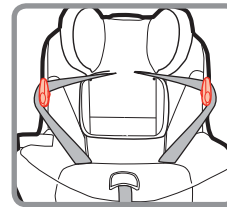

4. Place Harness Straps Out of Way

You can secure the harness straps around the harness holders as shown.

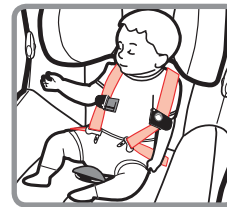

5. Place Child in Child Restraint to Determine Proper Harness Fit

The child's bottom and back should be flat against the child restraint.

See pages 5-6 for fit guidelines.

The soft infant-positioning wedge **MUST** be used for infants who weigh 5-11 lb (2.3-4.9 kg).

You **MUST** remove the soft infant-positioning wedge for children who weigh 15 lb (6.8 kg) or more.

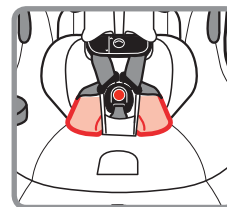

How Does Your Child Fit?

Use the guidelines below to determine if the buckle and harness strap are in the right place for your child.

REAR FACING



Buckle Position

Start in the 1st slot and adjust outward as your child grows.

Buckle should be used in the slot closest to your child. The buckle should not be underneath or behind your child.

1st or 2nd slot **MUST** be used.



Harness Strap Position

Harness strap **MUST** be at or slightly below shoulders.

Always choose the shoulder harness slot position that is closest to your child's shoulder height.

If the shoulder harness slots are above the child's shoulders with the headrest in the lowest position, **do not** use this child restraint.

To change buckle position, see pages 7-8.

To adjust headrest/harness height, see page 9.

FORWARD FACING



Buckle Position

Start in the 1st slot and adjust outward as your child grows.

Buckle should be used in the slot closest to your child. The buckle should not be underneath or behind your child.

Any slot can be used.



Harness Strap Position

Harness strap **MUST** be at or slightly above shoulders.

Always choose the shoulder harness slot position that is closest to your child's shoulder height.

If the shoulder harness slots are below the child's shoulders with the headrest in the highest position, **do not** use this child restraint.

To change buckle position, see pages 7-8.

To adjust headrest/harness height, see page 9.

Changing Position of Buckle

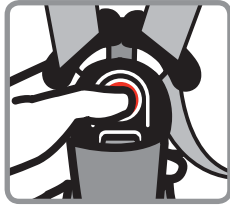

1. Unbuckle Harness

Press in towards the top of the red button.
Pull buckle tongues out.

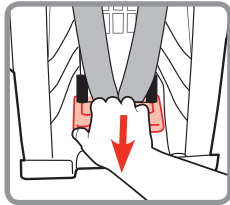

2. Fully Recline the Child Restraint

Pull out on recline handle and push top of child restraint back.

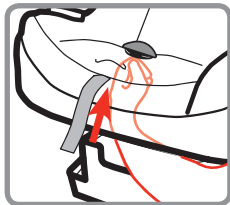

3. Locate Buckle's Metal Retainer

Reach under the seat between the base and shell and through the recline handle.

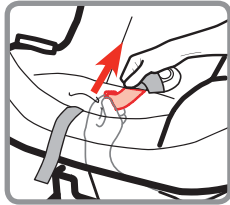

4. Rotate Metal Retainer and Push It Up Through Shell and Pad

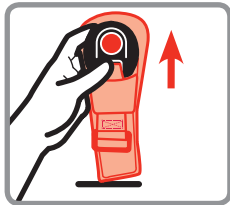

5. From Top of Seat, Pull Buckle and Buckle Cover Out of Shell and Pad



6. Slide Buckle Cover into Slot in Pad

You **MUST** use the 1st or 2nd buckle slots when child restraint is used rear facing. Any slot can be used when forward facing.

Buckle cover only goes through slot in pad. It lays flat underneath the pad as shown.

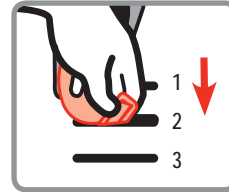
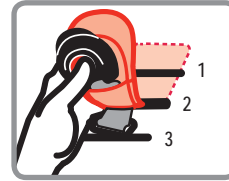

7. Insert Buckle's Metal Retainer into Same Slot as Buckle Cover

Buckle **MUST** face out.

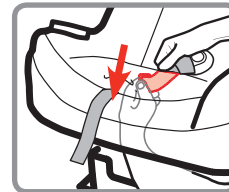

8. Reach Under the Seat Between Base and Shell

Pull buckle's metal retainer completely through pad and shell.



9. Check Buckle

Pull up on buckle to make sure it is secured.

The buckle **MUST** not pull out.

⚠ WARNING: Failure to place buckle's metal retainer completely through pad and shell can result in serious injury or death.

Adjusting Headrest/Harness Height

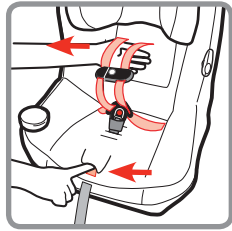

1. Fully Loosen Harness Straps

Push down on harness release lever (through opening in pad) while pulling out on harness straps as shown.

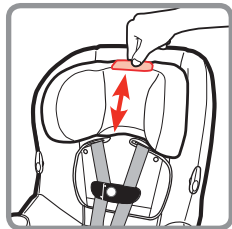

2. To Adjust Headrest/Harness Height

Squeeze the headrest adjustment handle.

Move the headrest up or down to the proper height for your child.

See pages 5-6 for fit guidelines.

Release it into slot to lock. Make sure it is securely locked into place.

⚠ WARNINGS: Make sure that the harness height is correct for your child's size.



Do not use this child restraint rear facing unless the top of your child's head is at least 1 in. (2.5 cm) below the top of the child restraint's headrest.



Do not use this child restraint forward facing if the tops of your child's ears are above the top of the child restraint's headrest.

Failure to follow these steps can result in serious injury or death.

Securing Child in Child Restraint



1. Place Child in Child Restraint

The child's bottom and back should be flat against the child restraint.

Position harness strap over child's shoulders and upper thighs.

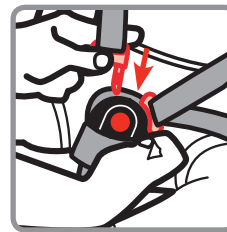

2. Buckle Harness

Push buckle tongues into buckle until you hear them "click."

Pull up on harness strap to make sure buckle is locked.

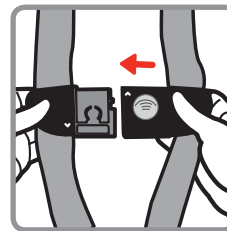

3. Close Chest Clip

Place the right clip piece on top of the left clip piece.

It will automatically snap together.

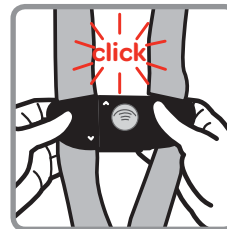

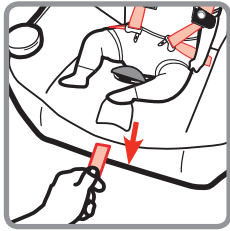

4. Tighten Harness

Pull on harness adjustment strap to tighten harness snugly.

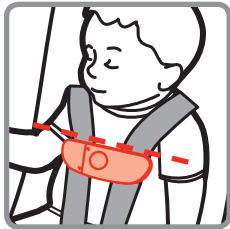

5. Position Chest Clip

The chest clip must be placed at mid-chest (even with armpits) and away from the child's neck.

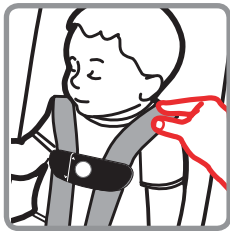

6. Check Harness Tightness

Try to pinch the harness at the shoulders vertically between index finger and thumb as shown.

If your fingers slip off, the harness is tight enough.

If you can pinch the harness strap, tighten more. The harness straps should be snug throughout their length.

A snug strap should not allow any slack. It lies in a relatively straight line without sagging. It does not press on the child's flesh or push the child's body into an unnatural position.

⚠ WARNINGS: Failure to fasten and tighten the harness system correctly may allow the child to be ejected from the child restraint in a crash or sudden stop causing serious injury or death.

Do not mistake comfort for safety. Harness system must be snugly adjusted.

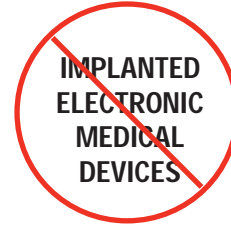

Do not use this chest clip with children who have an implanted electronic medical device.

A magnet is used to help secure the chest clip locking mechanism together which may interfere with the proper function of an implanted electronic medical device.

Parents or caregivers who have an implanted electronic device should keep their device away from the chest clip and consult their doctor and medical device manufacturer for specific information before using this chest clip.

If a parent/caregiver or child has an implanted electronic medical device, please contact Dorel (see page 58) for a replacement (non-magnetic) chest clip free of charge.



DO NOT put snowsuits or bulky garments on your child when placing them in the child restraint.

Bulky clothing can prevent the harness straps from being tightened properly.

To Remove Child From Child Restraint:

1. Loosen Harness Strap
2. Unbuckle Harness
3. Release Chest Clip
4. Place Harness Straps Out of Way Using Harness Holders
5. Remove Child

Reclining Child Restraint

This child restraint has 3 positions.

REAR FACING

The level-to-ground line on the side of shell **MUST** be level with the ground using either position 3 or 2.



FORWARD FACING

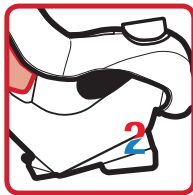

For Children
22-40 lb (10.1-18 kg)
29-43 in. (73.6-110 cm)
You **MUST** use position 2.

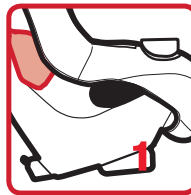

For Children
40-85 lb (18.1-38 kg)
43-52 in. (110.1-132.1 cm)
You **MUST** use position 1.

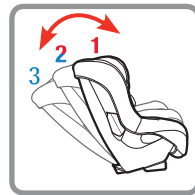
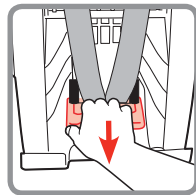

To recline, pull out on recline handle on the back of the child restraint and push top of child restraint back.

For upright, pull out on recline handle and pull top of child restraint forward.

Removing Seat Pad for Cleaning

You **DO NOT** need to remove the harness system to remove the pad from the shell. To remove accessories, see pages 19-20.

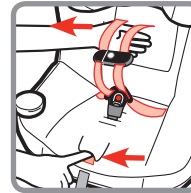

1. Fully Loosen Harness Straps

Push down on harness release lever (through opening in pad) while pulling out on harness straps as shown.



2. Unbuckle Harness

Press in towards the top of the red button.

Pull buckle tongues out.

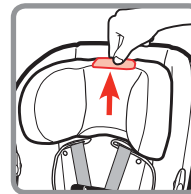

3. Adjust the Headrest to the Highest Position

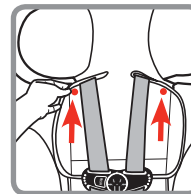

4. Undo Fasteners on Headrest Pad As Shown

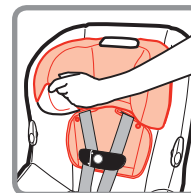

5. Remove Headrest Pad

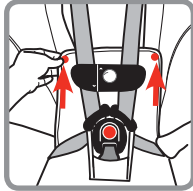

6. Undo Fasteners on Seat Pad

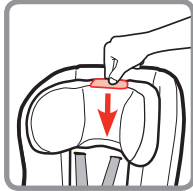

7. Lower Headrest to Lowest Position

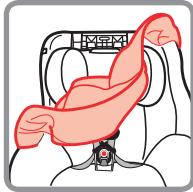

8. Remove Seat Pad

Gently pull the pad off the outside edges of the shell then around the headrest and harness holders.

Pull buckle and buckle pad through slot in seat pad.

⚠ WARNINGS: Do not use child restraint without the seat pad. Failure to do this can result in serious injury or death.

Cleaning Pad and Accessories

Machine wash separately with cold water on a gentle cycle. Make sure harness covers are closed so fastening strips are not exposed. Do not use bleach. Tumble dry separately for 10-12 minutes on low heat. Remove immediately.

Cleaning Easy Out Buckle Cover

Machine wash separately with cold water on a gentle cycle and air dry.

Cleaning Harness Strap

Spot clean using warm sudsy water and damp cloth.

Installing Seat Pad

See pages 16-18.

Installing Seat Pad

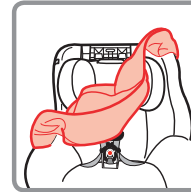

1. Slip Seat Pad Over and Behind Headrest

Lay pad in child restraint and slip pad over and behind the headrest.

Gently slide harness holders through slots in pad.

Pull buckle through slot in pad.

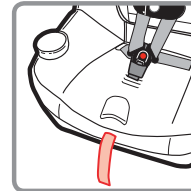

2. Pull Harness Adjustment Strap Through Slot in Pad

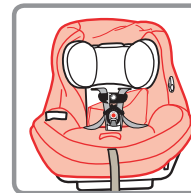

3. Pull Pad Over the Outside Edges of the Shell

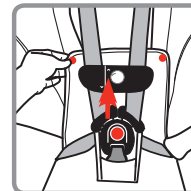

4. Attach Fasteners on Seat Pad

continued on next page

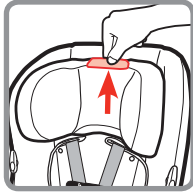

5. Adjust the Headrest to the Highest Position



6. Starting At Bottom of Headrest, Pull Headrest Pad onto Lower Portion of Headrest then Pull Headrest Pad Up Gently Over the Airbags and Upper Portion of Headrest

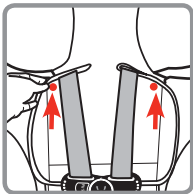

7. Attach Fasteners on Headrest Pad

If you have removed the harness straps from the splitter plate and the buckle tongues and chest clip have been unthreaded from the harness straps, follow the steps below to rethread them.

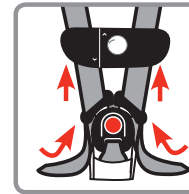

1. Thread Buckle and Chest Clip

Harness strap ends go through the **back** of buckle tongues and through the chest clip **front to back** as shown.

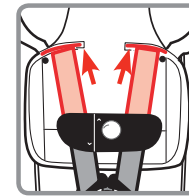

2. Thread Harness Straps into Shoulder Harness Slots

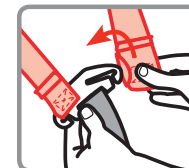

3. Attach Harness Strap Loops to Splitter Plate As Shown

Sewn ends of the harness strap loops **MUST** face towards you.

DO NOT twist harness strap or harness adjustment strap.

Make sure the harness strap loops are fitted **COMPLETELY ON** both sides of the splitter plate.

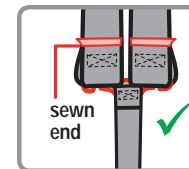

Correct

⚠ WARNINGS: Harness system must be installed correctly. Failure to follow these steps can result in serious injury or death.

Accessories on Select Models

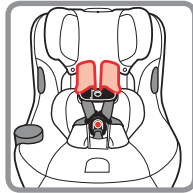

Harness Covers

Harness covers help provide comfort to the neck. If harness covers will not allow proper positioning of the chest clip or interfere with getting a tight enough fit for a smaller baby, remove and do not use.

Store until child is large enough to use these harness covers while maintaining a properly fitting harness.

To remove harness covers, pull the fastening strips apart and remove harness covers.



Harness Covers for Larger Children

These harness covers are located in the pocket on side of pad.

Only use these harness covers if your child weighs more than **65 lb (29 kg)** AND there is **NOT** a vehicle tether anchor available.

Undo the fastening strip and put the harness strap inside of harness cover.

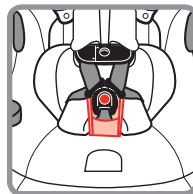
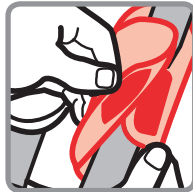

Easy Out Buckle Cover

To remove buckle cover, follow page 7 steps 1-5 to remove the buckle. Then pull the buckle up and out of the cover.

Replace the buckle.

To install buckle cover, see page 8.

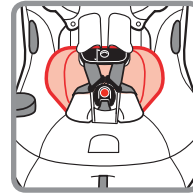

Body Pillow

Remove the body pillow when using the child restraint forward-facing.

To remove body pillow, loosen harness straps and slide pillow out from behind the harness straps.

To install body pillow, slide pillow behind infant-positioning wedge and harness straps.

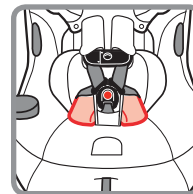

Soft Infant-Positioning Wedge

To remove soft infant-positioning wedge, undo the buckle and slide wedge from behind the harness straps.

The soft infant-positioning wedge **MUST** be used for infants who weigh 5-11 lb (2.3-4.9 kg).

You **MUST** remove the soft infant-positioning wedge for children who weigh 15 lb (6.8 kg) or more.

Child Restraint Use

Never take your child out of the child restraint while the vehicle is moving.

Never leave child unattended.

Placing your child in a hot child restraint may result in burns.

Do not use a child restraint with damaged or missing parts.

Do not use cut, frayed or damaged harnesses.

Do not substitute parts or try to modify the child restraint in any way.

Do not lubricate buckles and fasteners.

Do not use any child restraint accessory except those approved by Dorel Juvenile Group.

Never allow any child to play with this child restraint; it is not a toy.

Do not remove or cover up any of the warning labels or other labels on the child restraint.

Read all instructions for additional warnings.

On the side of the child restraint there is a date of manufacture label. Do not use this child restraint more than 10 years after the date of manufacture.

Installation in Vehicle

Check the vehicle belt or lower anchor belt before each use. Use only if the belt is tightened properly and locked securely in place.

This child restraint should be securely belted in the vehicle even when not in use. In a crash or sudden stop, an unsecured child restraint could injure occupants.

Do not use a child restraint that has been in a crash. You must get a new child restraint.

Vehicle Seating Position



Never place a child rear facing in a seating position with an active frontal air bag.

Check the vehicle owner's manual for more information about air bag/child restraint use.



Use the child restraint only on vehicle seats that face forward.

Do not use on seats that face the sides or rear of the vehicle.



Use the center seating position if possible.

For vehicles without a back seat, refer to your vehicle owner's manual.

If you are not sure where to place the child restraint in your vehicle, consult your vehicle owner's manual, contact Dorel Juvenile Group Consumer Care Department, or visit your local Child Passenger Inspection Station. Go to <http://www.safercar.gov/cpsApp/cps/index.htm> to find your closest station.



Children are safer when properly restrained in rear seating positions than in the front seating positions.

According to National Highway Traffic Safety Administration information, children in rear seating positions are statistically safer, whether you have air bags, advanced air bags, or no air bags at all.

To avoid your child being seriously burned, take the following precautions:

1. Park in the shade or where sun does not directly hit the child restraint.
2. Cover the child restraint with a sheet or blanket when not in use.
3. Check for hot seat and buckles before placing child in child restraint.

To help protect your vehicle seat's upholstery from damage, use a single layer towel underneath and behind child restraint.

Choosing Lower Anchor Belt or Vehicle Belts

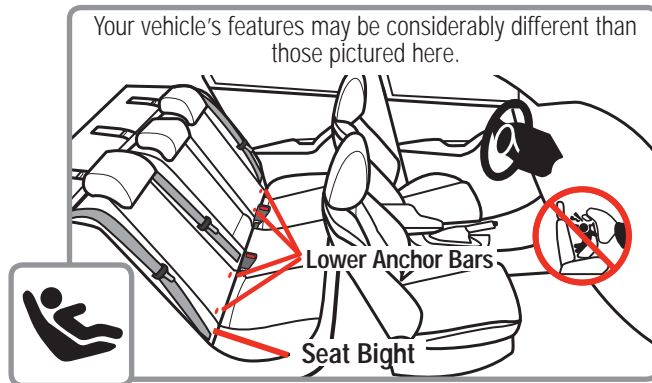

The LATCH System

The lower anchors of LATCH (Lower Anchors and Tethers for Children) is a universal system for installing child restraints without using vehicle seat belts.

The lower anchor system can **ONLY** be used in vehicles that have the lower anchor bars installed in designated LATCH seating positions.

Most vehicles manufactured after September 2002 are equipped with lower anchor bars.

Check your vehicle owner's manual to see which seating positions may be equipped with the LATCH system.

When installing with vehicle belts, the lower anchor belt **MUST be properly stored.**

Storing Lower Anchor Belt:

When installing rear facing with vehicle belts, thread lower anchor belt through forward-facing belt path. Then attach connectors to storage attachment as shown. Gently pull free end of belt to remove slack.

When installing forward facing with vehicle belts, thread lower anchor belt through rear-facing belt path. Then attach connectors to storage attachments as shown. Gently pull free end of belt to remove slack.

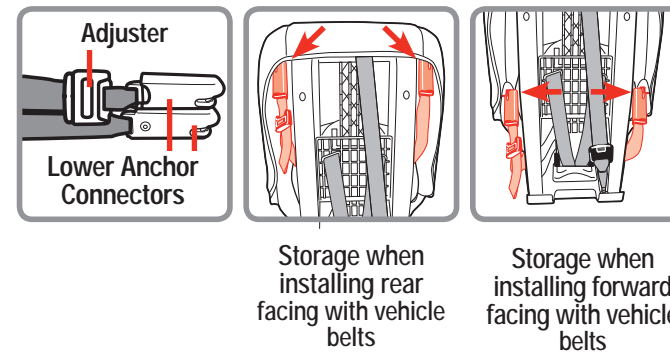

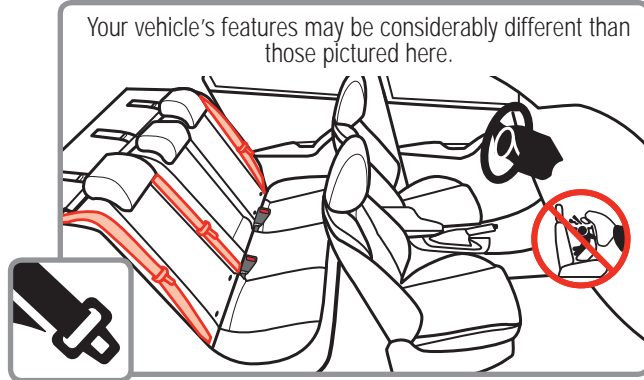

Vehicle Belts

If lower anchors are not an option or if your child weighs more than 40 lb (18 kg), you must use the vehicle seat belt system to install the child restraint.

There are some vehicle belts that will not work with a child restraint or will require special attention. Check your vehicle owner's manual for specific instructions.

⚠️ WARNINGS: When used correctly the lower anchor belt or vehicle belts are equally safe.

Do not use both the lower anchor belt and vehicle belt at the same time.

Knowing Your Vehicle Belts

Not all vehicle belts and seating positions will work with child restraints. Please follow the following steps to understand how to lock a child restraint with a vehicle belt.

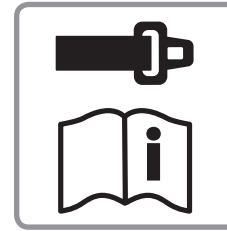

1. You MUST Review Your Vehicle Owner's Manual

Your vehicle owner's manual will let you know what vehicle belts and seating positions child restraints can be installed in.



2. Determine How the Child Restraint Will Be Locked Into Place

The vehicle belt **MUST NOT** loosen after tightening.

This means there needs to be a way to lock the vehicle belt.

The ways this can be done are:

- By using the seat belt's retractor; or
- By using the seat belt's latch plate.

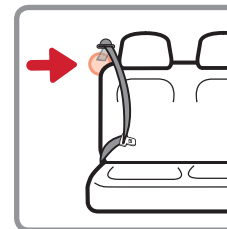

3. Check the Retractor

Retractors pull seat belts into stored positions and lock the belt to hold passengers in place.

A retractor is most likely how you will be locking a child restraint into place.

See the next page for some common types of vehicle belt retractors that will work with this child restraint.

Types of Retractors

Switchable Retractor
(most vehicles have this type)



This retractor can be switched to a locking mode.

You **MUST** have the retractor in the locking mode to use the seat belt with this child restraint.

Switching to locking mode: Slowly pull the shoulder belt all the way out, then let it go back in an inch or two.

As it goes back in, you will most likely hear a ratcheting sound.

Gently pull the belt to see if it has locked. You will not be able to pull any more belt out if the lock has engaged.

Automatic Locking Retractor



This retractor always locks.

It will automatically lock after slowly pulling the seat belt out at least halfway and letting the belt go back into the retractor an inch or two.

Emergency Locking Retractor

See Step 4, "Check the Latch Plates," on next page.

If the retractor does not lock, it is most likely an Emergency Locking Retractor. These retractors only lock during a sudden stop or collision.

You will need to determine if your seat belt's latch plate can lock the belt. See Step 4, "Check the Latch Plates," on next page.

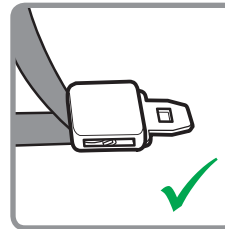
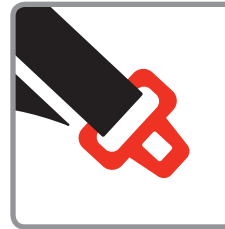

Locking Latch Plate

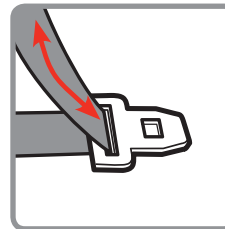

Emergency Locking Retractor with a Sliding Latch Plate

4. Check the Latch Plates

Latch plates are the part of the seat belt that goes into the buckle.

Hold the lap belt with one hand and with your other hand grasp the tongue of the latch plate (the part that goes inside the buckle). Pull the latch plate straight out in line with the lap belt.

If the latch plate does not slide up and down the vehicle belt, it is a **locking latch plate**.

If the latch plate slides up and down the vehicle belt, it is a **sliding latch plate**.

Sliding latch plates easily slip between the lap and shoulder portions of the belt.

If you have an Emergency Locking Retractor with a Sliding Latch Plate, you **MUST** use a locking clip to install the child restraint. See pages 50-52.

Never Use With This Child Restraint

Emergency Locking Retractor Lap Only Belt



Inflatable Seat Belts



Aircraft Information



This restraint is certified for aircraft use.

Install the child restraint in a window seat to avoid blocking the aisle. If the aircraft lap belt is too short, ask the flight attendant for a belt extender.

Use only on forward facing aircraft seats.

Contact the airline for their specific policies.

Some airlines may ask to see a label stating that this child restraint is certified for aircraft use.

There is an airplane certification label located on the side of this child restraint as shown.

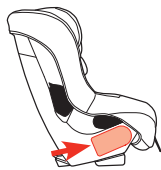

⚠ WARNING: Store lower anchor belt and tether strap when using the aircraft belts.



Rear Facing Aircraft Installation

For rear facing installation follow pages 36-39.



Forward Facing Aircraft Installation

For forward facing installation follow pages 47-49.

Rear Facing



5-40 lb (2.3-18 kg)

40 in. (101.6 cm)
or less

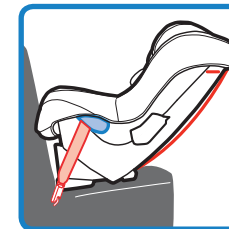

Lower Anchor Belt

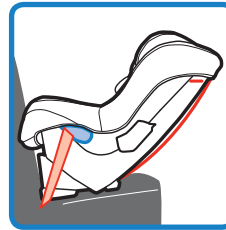

Lap Belt

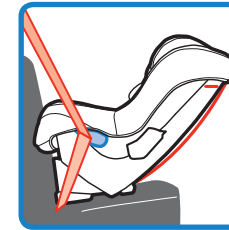

Lap/Shoulder Belt



⚠ WARNINGS: Never install a rear facing child restraint in the front seat of a vehicle equipped with an active frontal airbag.

This child restraint **MUST** always face the rear of the vehicle when the child is less than 1 year old.

The American Academy of Pediatrics recommends that children remain rear facing until they are at least 2 years old.

Please talk to your doctor about the best option for your child.

Lower Anchor Belt Installation

⚠ WARNINGS: Do not use the lower anchor belt along with the vehicle lap or lap/shoulder belt.

Check the lower anchor belt before each use. Use only if the belt can be tightened properly and securely.

Do not fasten multiple lower anchor connectors on the same lower anchor bar in the vehicle.

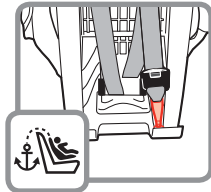

Store the tether hook when used rear facing. Attach the tether hook to storage attachment as shown.

Failure to follow these warnings can result in serious injury or death.

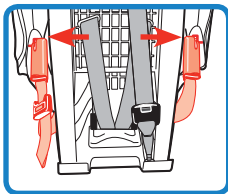

1. Remove Lower Anchor Belt from Storage Location

Or if the lower anchor belt was used forward facing, pull it out of the forward-facing belt path so both connectors are on the same side of the seat as shown.

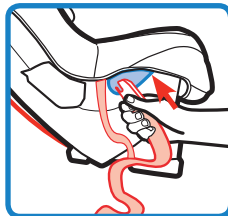
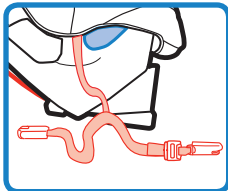

2. Route the Connector without the Adjuster Closest to it Through the Rear-Facing Belt Path As Shown

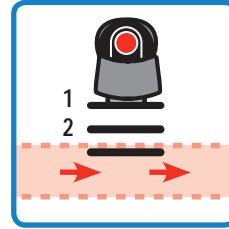

3. Reach Under Pad and Pull Connector Across to Opposite Side

Do not twist belt.

Belt **MUST** be in front of buckle strap and under pad.

You **MUST** use the 1st or 2nd buckle slot.

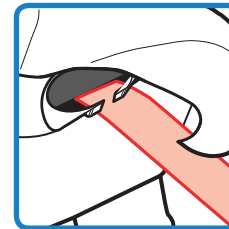

4. You **MUST** Thread the Lower Anchor Belt into Belt Positioning Guides on Both Sides of Shell As Shown

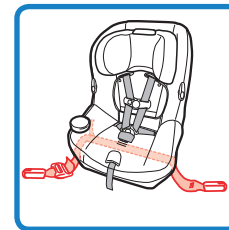

5. Finished Lower Anchor Belt Routing

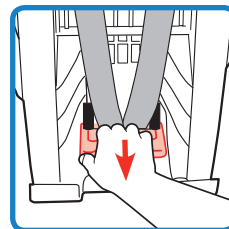

6. Fully Recline the Child Restraint

Pull out on recline handle and push top of child restraint back.

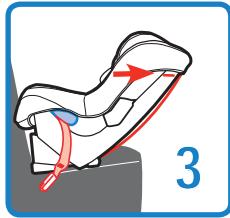

7. Place Child Restraint Rear Facing in Back Seat

The level line on shell **MUST** be parallel with the ground.

If needed, you may use position 2 to help achieve the correct recline angle.

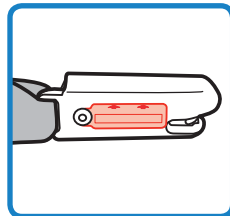

8. Attach Lower Anchor Connector to Vehicle's Lower Anchor

Review your vehicle owner's manual for lower anchor locations and lower anchor belt use.

Make sure arrows on connectors are facing up.

Fasten one lower anchor belt connector to the anchor located in the vehicle seat bight.

Repeat for other side of child restraint.

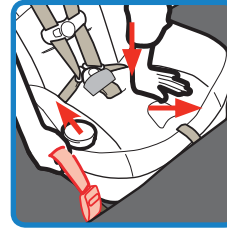
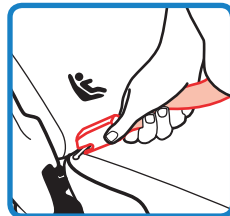

9. Tighten Belt

Place hand in child restraint.

Firmly push child restraint down and back towards the vehicle seat back while pulling free end of belt to tighten.

It may be easier to pull back the pad and pull the free end of the belt parallel with the belt path as shown.

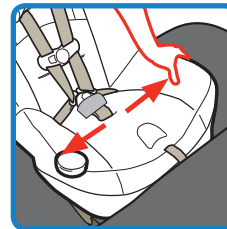
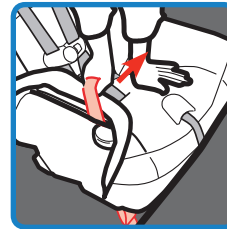

10. Check Belt Tightness

Hold child restraint at the belt path with your weakest hand.

Push and pull from side to side.

It should not move more than 1 in. (2.5 cm).

If it moves more than 1 in. (2.5 cm), you can try:

- A. Pulling the belt tighter.
- B. Reinstalling the child restraint.
- C. Changing to a different seating location.
- D. Switching to vehicle belt installation.



11. Secure Child in Child Restraint

See pages 10-12.



12. Recheck Level Line

Repeat steps 6-12 if not reclined correctly.

NOTE: You may need to place a large rolled towel(s) or foam pool noodle(s) under front of child restraint to help achieve the correct recline angle.

Check often to be sure padding is still in place and the belt is tight.

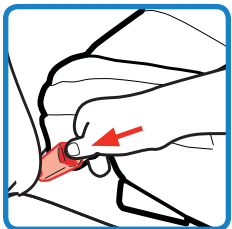

To Release Lower Anchor Belt

Remove child from child restraint.

Remove lower anchor belt from vehicle anchors by pressing the red release button on each connector. Then pull it out of the vehicle seat.

Store lower anchor belt when not in use. See page 24.



Vehicle Belt Installation

⚠ WARNINGS: Do not use the lower anchor belt along with the vehicle lap or lap/shoulder belt.

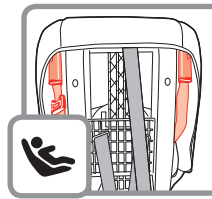

Secure the lower anchor connectors to storage attachments as shown when installing with vehicle belts.

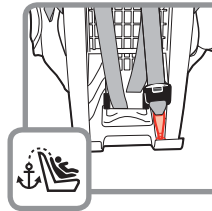

Store the tether hook when used rear facing. Attach the tether hook to storage attachment as shown.

Check the vehicle belt before each use. Use only if the belt can be tightened properly and locked securely in place.

Failure to follow these warnings can result in serious injury or death.

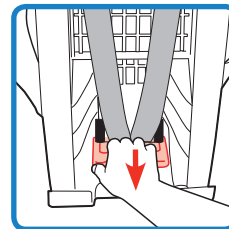

1. Fully Recline the Child Restraint

Pull out on recline handle and push top of child restraint back.



2. Place Child Restraint Rear Facing in Back Seat

The level line on shell **MUST** be parallel with the ground.

If needed, you may use position 2 to help achieve the correct recline angle.



3. Check if Your Vehicle Belts Will Work With This Child Restraint

This is very important because **not all vehicle belts will work with child restraints.**



Review pages 26-28 and your vehicle owner's manual to determine what kind of vehicle belt you have and how to lock a child restraint in place.

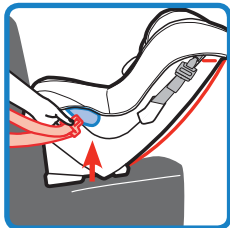

4. Route Vehicle Lap or Lap/Shoulder Belt Through Rear-Facing Belt Path

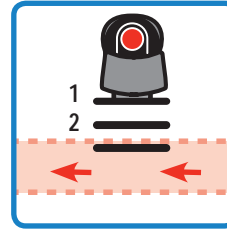

5. Reach Under Pad and Pull Vehicle Belt Across the Shell

Do not twist belt. Belt **MUST** be in front of buckle strap.

You **MUST** use the 1st or 2nd buckle slot. Do not place belt over child's legs.

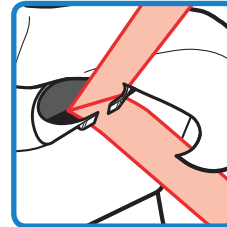

6. You MUST Thread Only the Vehicle Lap Belt into the Belt Positioning Guides on Both Sides of the Shell As Shown

DO NOT thread the shoulder portion of the lap/shoulder belt into the belt positioning guides.

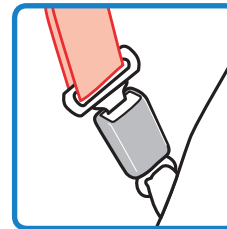

7. Buckle Vehicle Belt

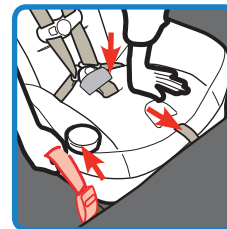

8. Tighten Belt

Place hand in child restraint.

Firmly push child restraint down and back towards the vehicle seat back while pulling free end of belt to tighten.

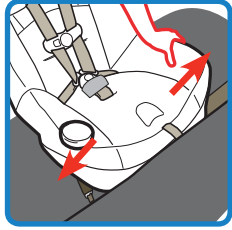

9. Check Belt Tightness

Hold child restraint at the belt path with your weakest hand.

Push and pull from side to side.

It should not move more than 1 in. (2.5 cm).

If it moves more than 1 in. (2.5 cm), you can try:

- A. Pulling the belt tighter.
- B. Reinstalling the child restraint.
- C. Changing to a different seating location.
- D. Switching to lower anchor belt installation if lower anchors are available in your vehicle.



10. Secure Child in Child Restraint

See pages 10-12.

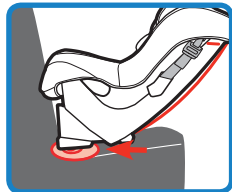
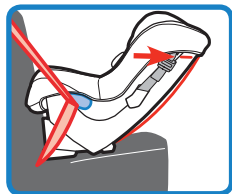

11. Recheck Level Line

Repeat steps 2-11 if not reclined correctly.

NOTE: You may need to place a large rolled towel(s) or foam pool noodle(s) under front of child restraint to help achieve the correct recline angle.

Check often to be sure padding is still in place and the belt is tight.

Forward Facing



For Children
22-40 lb (10.1-18 kg)
29-43 in. (73.6-110 cm)
At least 1 year old

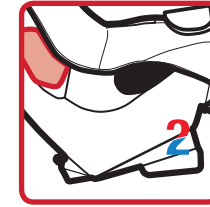

You **MUST** Use Position

2

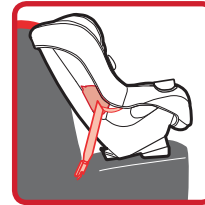

Lower Anchor Belt with Tether



Lap Belt with Tether



Do not install by this method for a child weighing more than 40 lbs (18 kg).



Lap/Shoulder Belt with Tether



⚠ WARNINGS: In this child restraint your child **MUST** be at least 1 year old before they sit forward facing.

The American Academy of Pediatrics recommends that children remain rear facing until they are at least 2 years old and remain in a five-point harness until they outgrow their forward-facing harnessed child restraint.

Please talk to your doctor about the best option for your child.

continued on next page

Forward Facing



For Children

40-85 lb (18.1-38 kg)

43-52 in. (110.1-132.1 cm)

At least 1 year old



You MUST Use Position 1



Lap Belt with Tether

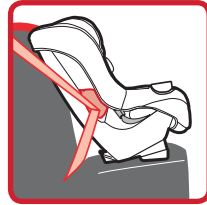

Lap/Shoulder Belt with Tether



Harness Covers for Larger Children

Only use the harness covers for larger children if your child weighs more than **65 lb (29 kg)** AND there is **NOT** a vehicle tether anchor available. See page 20.

⚠️ WARNINGS: In this child restraint your child **MUST** be at least 1 year old before they sit forward facing.

The American Academy of Pediatrics recommends that children remain rear facing until they are at least 2 years old and remain in a five-point harness until they outgrow their forward-facing harnessed child restraint.

Tether Use

You **MUST** always attach, adjust, and secure the top anchorage (tether) strap when installing the child restraint forward facing with internal harness. Tethers improve the installation and stability of child restraints and reduce the risk of injury.

Attach the tether hook to the tether anchor designated by your vehicle manufacturer for that seating position. Check your vehicle owner's manual for more information.

If the seating position does not have a tether anchor, use a different seating position or see your dealer or a qualified mechanic and have one installed.

⚠️ WARNING: Do not fasten multiple tether hooks on the same tether anchor in the vehicle.



Adjusting Tether Strap

To tighten: After the child restraint is locked into place with lower anchor belt or vehicle belt, push down on child restraint and gently pull on free end of tether.



To loosen: Lift up on tether lock adjuster and push it towards tether hook.

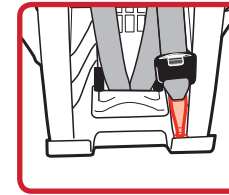

Storing Tether Strap

When installing rear facing or when **not in use**, attach the tether hook to its storage attachment on back of shell as shown.

Gently tighten to remove slack.

Lower Anchor Belt Installation

⚠ WARNINGS: Do not use the lower anchors of the child restraint anchorage system (LATCH system) to attach this child restraint when restraining a child weighing more than 40 lbs (18 kg).

The vehicle belt must be used for installation if your child weighs more than 40 lb (18 kg).

Do not use the lower anchor belt along with the vehicle lap or lap/shoulder belt.

Check the lower anchor belt before each use. Use only if the belt can be tightened properly and securely.

Do not fasten multiple lower anchor connectors on the same lower anchor bar in the vehicle.

Failure to follow these warnings can result in serious injury or death.

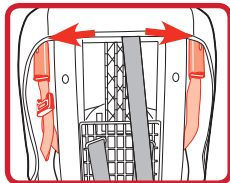

1. Remove Lower Anchor Belt from Storage Location

Or if the lower anchor belt was used rear facing, pull it out of the rear-facing belt path so both connectors are on the same side of the seat as shown.

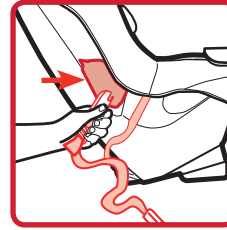
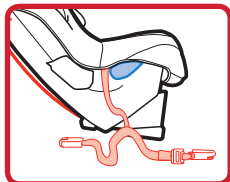

2. Route the Connector with the Adjuster Closest to it Through the Forward-Facing Belt Path As Shown



3. Finished Lower Anchor Belt Routing

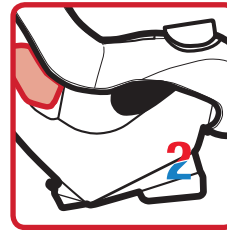

4. Recline Child Restraint to Position 2

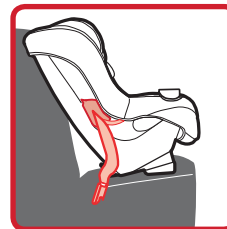

5. Place Child Restraint Forward Facing Against Vehicle Seat Back

Vehicle seat back must be upright.

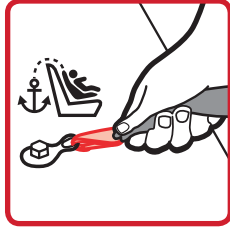

6. Loosely Attach Tether Hook to Vehicle's Tether Anchor

Check vehicle owner's manual for specific location.

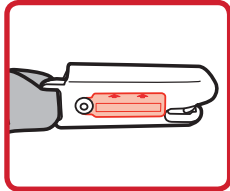

7. Attach Lower Anchor Connector to Vehicle's Lower Anchor

Review your vehicle owner's manual for lower anchor locations and lower anchor belt use.

Make sure arrows on connectors are facing up.

Fasten one lower anchor belt connector to the anchor located in the vehicle seat bight.

Repeat for other side of child restraint.

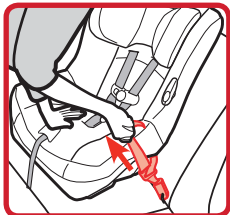

8. Tighten Belt

Place hand in child restraint.

Firmly push the child restraint down while pulling the free end of belt to tighten.

It may be easier to pull back the pad and pull the free end of the belt parallel with the belt path as shown.

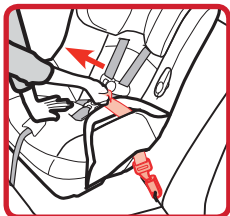

9. Tighten Tether

Push firmly on the back of the seat and pull the tether strap to remove all slack and create tension on the strap.

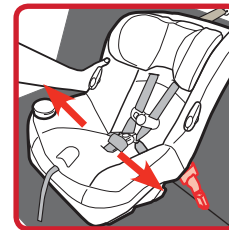

10. Check Belt Tightness

Hold child restraint at the belt path with your weakest hand.

Push and pull from side to side.

It should not move more than 1 in. (2.5 cm).

If it moves more than 1 in. (2.5 cm), you can try:

- A. Putting your knee in the seat and pulling the belt tighter.
- B. Reinstalling the child restraint.
- C. Changing to a different seating location.
- D. Switching to vehicle belt installation.

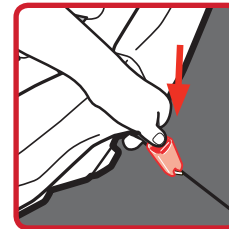

To Release Lower Anchor Belt

Remove child from child restraint.

Remove lower anchor belt from vehicle anchors by pressing the red release button on each connector. Then pull it out of the vehicle seat.

Store lower anchor belt when not in use. See page 24.

Vehicle Belt Installation



⚠ WARNINGS: Do not use the lower anchor belt along with the vehicle lap or lap/shoulder belt.

Secure the lower anchor connectors to storage attachments as shown when installing with vehicle belts.

Check the vehicle belt before each use. Use only if the belt can be tightened properly and securely.

Failure to follow these warnings can result in serious injury or death.

1. Place Child Restraint in Correct Position

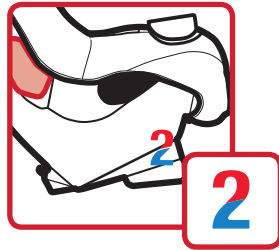

For Children
22-40 lb (10.1-18 kg)
29-43 in. (73.6-110 cm)
You **MUST** use position **2**.



For Children
40-85 lb (18.1-38 kg)
43-52 in. (110.1-132.1 cm)
You **MUST** use position **1**.



2. Place Child Restraint Forward Facing Against Vehicle Seat Back

Vehicle seat back must be upright.

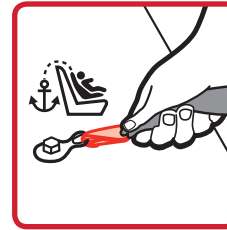

3. Loosely Attach Tether Hook to Vehicle's Tether Anchor

Check vehicle owner's manual for specific location.



4. Check if Your Vehicle Belts Will Work With This Child Restraint

This is very important because **not all vehicle belts will work with child restraints.**

Review pages 26-28 and your vehicle owner's manual to determine what kind of vehicle belt you have and how to lock a child restraint in place.

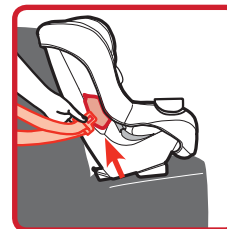

5. Route Vehicle Lap or Lap/Shoulder Belt Through Forward-Facing Belt Path

Do not twist belt.

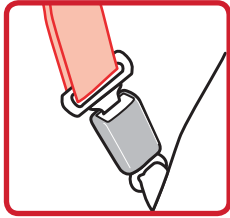

6. Buckle Vehicle Belt

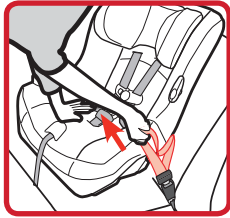

7. Tighten Belt

Place hand in child restraint.

Firmly push the child restraint down while pulling the shoulder belt or the free end of lap belt towards you as shown.

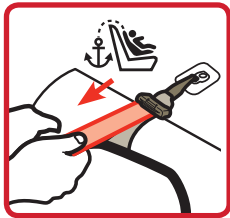

8. Tighten Tether

Push firmly on the back of the seat and pull the tether strap to remove all slack and create tension on the strap.

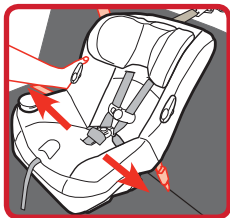

9. Check Belt Tightness

Hold child restraint at the belt path with your weakest hand.

Push and pull from side to side.

It should not move more than 1 in. (2.5 cm).

If it moves more than 1 in. (2.5 cm), you can try:

- A. Putting your knee in the seat and pulling the belt tighter.
- B. Reinstalling the child restraint.
- C. Changing to a different seating location.
- D. Switching to the lower anchor belt installation if lower anchors are available in your vehicle.

Using a Locking Clip

You will rarely need to use a locking clip except in some older vehicles. Built-in child restraint locking systems have been required in vehicles since 1996, and many vehicles had these features even earlier.

Review pages 26-28 and your vehicle owner's manual to determine if your vehicle belts require a locking clip.

If you need a locking clip immediately, they are likely available at an auto dealership, an auto store, or where you purchased this child restraint.

You can also email call us at 1-800-951-4113 for one.

A locking clip will not fix all types of seat belt problems. You **MUST** have a lap and shoulder belt to use a locking clip.

For Rear Facing installation, follow pages 36-38 Warnings and Steps 1-8 before starting locking clip installation.

For Forward Facing installation, follow pages 47-49 Warnings and Steps 1-7 before starting locking clip installation.

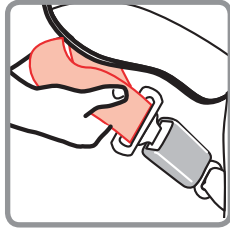

1. Determine Locking Clip Position

Grasp both vehicle belts together just behind the latch plate to mark the position for locking clip.

Unbuckle the belt.

NOTE: If the latch plate ends up just at the belt path opening so you cannot grasp the vehicle belt at the latch plate, grasp the vehicle belts on the opposite side of the child restraint, as close to the latch plate as possible.

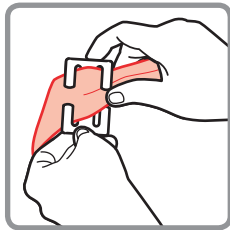

2. Attach Locking Clip

Thread both portions of the vehicle belt onto the locking clip, as close to the latch plate as possible.

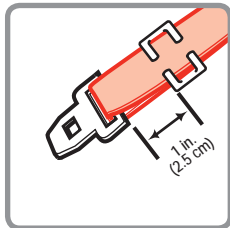

3. Position Locking Clip

It should be about 1 in. (2.5 cm) from vehicle belt's latch plate.

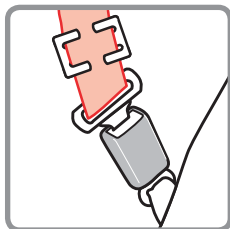

4. Rebuckle Vehicle Belt

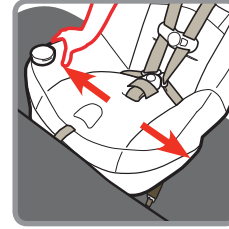

5. Check Belt Tightness

Hold child restraint at the belt path with your weakest hand.

Push and pull from side to side.

It should not move more than 1 in. (2.5 cm).

If it moves more than 1 in. (2.5 cm), you can try:

A. Reinstalling the child restraint.

B. Changing to a different seating location.

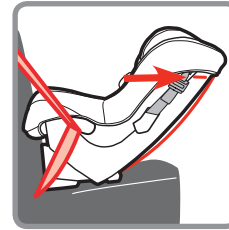

When installed rear facing, recheck the level line.

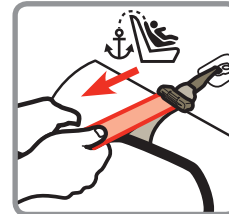

When installed forward facing, make sure to tighten the tether strap.

Remove the locking clip when the seat belt is not being used with a child restraint.

Registration and Safety Notices

Please complete the postage-paid registration card that came with your child restraint, and send it to us. Child restraints could be recalled for safety reasons. You must register this restraint to be reached in a recall. Send your name, address, email address if available and the restraint's model number and manufacturing date to:

Dorel Juvenile Group, Inc.
Consumer Care Department
PO Box 2609
Columbus, IN 47202-2609

or call 1-800-951-4113 or register online at www.djgusa.com/registration/carseat/us.

For recall information, call the U.S. Government's Vehicle Safety Hotline at 1-888-327-4236 (TTY: 1-800-424-9153), or go to <http://www.NHTSA.gov>.

0515079 Tear Off and Mail This Part or Register Online 434840610

Consumer: Just fill in your name, address and email. Please print (use dark ink).

Your Name _____

Your Street Address _____

City _____ State _____ Zip Code _____

Model Number (optional) _____ Line Code _____ Manufacture Date _____

Model Number: AB123CDE Model Name: MAXICOSI CARSEAT Manufacture Date: 01/22/2015

L#11 B265035

Example of model number, manufacture date, and line code.

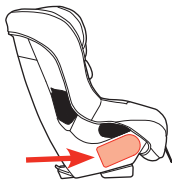

If you don't have the card or if your address changes, you will find the model number, manufacture date, and line code on the label located on side of shell.

Warranty

Dorel Juvenile Group, Inc. (DJG) warrants this product to the original retail purchaser as follows:

This product is warranted against defective materials or workmanship for one year from the date of original purchase. **An original receipt is required to validate your warranty.** DJG will, at its option, provide replacement parts or replace this product. DJG reserves the right to substitute if the part or model has been discontinued.

To make a claim under this warranty write to DJG, Consumer Care Department, P. O. Box 2609, Columbus, IN 47202-2609; or call 1-800-951-4113 from 8:00 a.m. to 6:00 p.m. EST Monday through Thursday and from 8:00 a.m. to 4:30 p.m. on Friday.

Proof of purchase is required and shipping charges are the responsibility of the consumer.

Warranty Limitations: This warranty does not include damages which arise from misuse or abuse of this product.

Limitation of Damages: The warranty and remedies as set forth are exclusive and in lieu of all others, oral or written, expressed or implied. In no event will DJG or the dealer selling this product be liable to you for any damages, including incidental or consequential damages, arising out of the use or inability to use this product.

Limitation of warranties and other warranty terms and state law rights:

Any implied warranties, including implied warranties of the merchantability and fitness for a particular purpose, shall be limited to the duration and terms of the express written warranty. Some states do not allow limitations as to how long an implied warranty lasts or the exclusion or limitation of incidental or consequential damages, so the above limitations may not apply to you.

This warranty gives you specific legal rights, and you may have other rights, which vary from state to state. Neither DJG nor the

dealer selling this product authorized any person to create for it any other warranty, obligation, or liability in connection with this product.

Please note: Our product warranty only applies when purchased from an authorized Maxi-Cosi retailer. The origin of products not purchased through these authorized retailers is unknown and could be counterfeit. We cannot support products from an unknown origin as we cannot verify the handling or condition of such merchandise. We maintain a strong network of authorized retailers to ensure you are purchasing safe and complete products. Fulfillment by a third party does not guarantee you are purchasing from one of these authorized retailers. Pricing which is inconsistent with the majority of retailers is a strong indication that the retailer is not authorized, as we have a consistent price offering across all authorized retailers. If you are unsure of the authorization status of a retailer you are considering purchasing from, or have purchased from, you can check www.maxi-cosi.com/us-en/shops.aspx or call our Consumer Care department at 1-800-951-4113.

Replacement Parts Order Form

Complete the form. Your model number and manufacturer date code **MUST** be included on the form to ensure proper replacement parts. The codes can be found on a label on side of child restraint. Payment in U.S. dollars must accompany your order. Choose parts needed from the list on the next page. Return the form with payment to:

Dorel Juvenile Group, Inc.
Consumer Care Department
P.O. Box 2609
Columbus, IN 47202-2609

Please make money orders payable to Dorel Juvenile Group, Inc. Fill in the area on the next page to charge credit card. (Visa or MasterCard **only**). We do not accept cash, personal checks, or other credit cards. All outside of U.S. and Canada **MUST** use credit card.

Ship To: (Please Print)

Name: _____

Address: _____

City: _____

State/Province: _____ **Zip:** _____

Telephone: _____

Email Address: _____

We **MUST** have this information:

Model Number (8 to 9 characters): _____

Manufacture Date (mm/dd/yyyy): _____

Replacement Parts List

NOTE: If requested color is not available, similar color will be substituted. Prices are subject to change.

Part	Cost	Qty	Total Cost
Buckle Assembly.....	\$7.99	_____	\$_____
Seat Pad Set.....	\$109.99	_____	\$_____
ClipQuik™ Chest Clip.....	\$25.00	_____	\$_____
Tether.....	\$6.00	_____	\$_____
Lower Anchor Belt.....	\$24.99	_____	\$_____
Instructions.....	\$0.00	_____	\$_____
Locking Clip.....	\$2.50	_____	\$_____
Merchandise Total:			\$_____
Shipping and handling:			\$_____

Up to \$25.00.....	\$5.95	\$100.01 to \$150.00.....	\$10.95
\$25.01 to \$50.00.....	\$6.95	\$150.01 to \$200.00.....	\$11.95
\$50.01 to \$75.00.....	\$8.95	\$200.01 and up.....	\$13.95
\$75.01 to \$100.00.....	\$9.95	Outside Continental USA.....	\$10.00

Sales Tax.....\$_____

(Arizona, California, Georgia, Indiana, Missouri, South Carolina, and Texas residents add applicable sales tax.)

Grand Total.....\$_____

No shipping and handling on instructions for quantities under 6. Add \$.50 for each instruction over 6, then add applicable shipping and handling.

Fill Out For Credit Card
 Visa MasterCard

Card Exp. Date:

Cardholder's Name:

Card Number:

Signature:

Troubleshooting

1. Locate a Child Safety Seat Inspection Station for hands on training on how to use your child restraint: Visit your local Child Passenger Inspection Station or go to <http://www.safercar.gov/cpsApp/cps/index.htm> to find your closest station.

2. If the child restraint buckle or harness release lever sticks or you cannot get the straps tight enough around child: DO NOT LUBRICATE. Check around lever and retractor for dropped food, sticky spilled drinks, dirt, leaves, etc. Clean with warm water and/or remove object with tweezers. If you cannot get the harness to adjust and remain tight with the buckle securely locked, do not use the child restraint.

3. If your harness twists: Straighten the harness each time you put your child in the child restraint to help prevent twisting. Lock the buckle and tighten harness so it will be ready for next use.

Dorel Juvenile Group Information

Thank you for choosing this child restraint. The DJG family is committed to creating child restraints with the most comfort and convenience available today.

Remember, parents are a child's first teachers and examples. If you always buckle your seat belt, your child will think it is the natural thing to do. Make it a firm rule that the vehicle does not go until everyone is buckled up. Make no exceptions.

No one can predict if use of a child restraint will prevent injury or death in a particular crash. However, when combined with careful driving, proper use of a child restraint can lower a child's risk of injury or death in most crashes.

Your child's safety is worth the time it will take to read and follow these instructions. After reading, if you still have questions or have any concerns with this child restraint, please contact our Consumer Care Department at:

Website: www.maxi-cosi.com

Telephone: 1-800-951-4113

M-TH from 8 A.M. to 6 P.M. EST
 FRI from 8 A.M. to 4:30 P.M. EST

Mailing Address:

Dorel Juvenile Group, Inc.
 Consumer Care Department
 P.O. Box 2609
 Columbus, IN 47202-2609

CUT ON DOTTED LINE